

Description

The LIFECO Medium Velocity Water Spray Nozzles are open type (non-automatic nozzles, designed for directional spray application in fixed fire protection system.

Medium velocity water spray nozzle has an external deflector, which discharges water in a directional cone shaped pattern of small droplet size. The water is uniformly distributed over the surface to be protected.

The Nozzles are effectively designed to apply water to exposed vertical, horizontal, curved and irregular shaped surfaces to allow cooling to prevent excessive absorption of heat from external fire and avoid structural damage or spread of fire. In some application nozzles may be installed to control or extinguish the fire depending on water design density as per applicable codes. The nozzle is used in deluge water spray system for special hazard fire protection application.

As the design and intent of specific water spray system may vary considerably, MV nozzle is made available in several combinations of orifice sizes and spray angles.

The minimum desirable pressure to achieve a reasonable spray pattern is 1.4 Kg./Sq.cm. The water distribution pattern as shown in the graph in following pages is at an average pressure of 2.0 Kg./Sq.cm. The change in pressure between 1.4 to 3.5 Kg./sq.cm. does not affect considerable change in spray angle.

The spray pattern shown is with indoor application. System designer must consider wind velocity while designing the system for outdoor application. Field obstruction if any affecting the spray pattern of the nozzle must also be considered. The nozzle may be oriented to any position as deemed necessary to cover the hazard.

The Blow-off plugs can be used to prevent the depositing of foreign materials in the water way of the nozzles, which could interfere with discharge of the spray nozzle. Blow-off plugs are optional. Blow-off Plugs have identification mark with respect to K factor. Blow off plug for nozzle having K-factor 22 will have identification mark of 22. Minimum operationing pressure for nozzle having Blow-off plug is 1.4 Kg./Sq.cm (20 PSI).

The main pipeline strainer as per NFPA-15 is required for system utilizing nozzle orifice diameter less than 9.5mm (3/8 inch), i.e.MV Nozzle having K-factor 51 and less, and also for the system water likely to contain obstructive materials.

Technical and Environmental Specification

Model	A Brass material (w/o strainer) AS Brass material (w/ strainer) BS Stainless steel material (w/ strainer)	
Maximum Working Pressure	12 Bar (175 PSI)	
End Connection	½" BSPT (½" NPT OPTIONAL)	
Included Water Spray Angle For Each K-Factor	140°, 120°, 110°, 100°, 90°, 80° & 65°	
K-Factor	A	AS & BS
	Metric (US)	Metric (US)
	K-18 (1.26)	K-18 (1.26)
	K-22 (1.54)	K-22 (1.54)
	K-30 (2.10)	K-30 (2.10)
	K-35 (2.45)	K-35 (2.45)
	K-41 (2.87)	K-41 (2.87)
	K-51 (3.6)	
	K-64 (4.5)	
	K-79 (5.5)	
K-91 (6.4)		
K-102 (7.2)		
Weight (Approx)	0.110 Kg	
Finish	A & AS	
	Natural Brass finish, Chrome plated Nickel, Electroless Nickel plated, Epoxy powder coated.	
Approvals	BS	
	Natural finish	
Ordering Information	UL Listed	
Ordering Information	Specify K-Factor, spray angle, finish, model and end connection	

Installation & Maintenance

The spray nozzle must be handled with due care. For best results, the storage as well as any further shipment be made in original packing only.

Nozzle which is visibly damaged should not be installed. Use Teflon tape or soft thread sealant on male thread of the nozzle.

The nozzles must be hand tightened into the fitting. After hand tightening use Nozzle Wrench NW-M for wrench tightening in to nozzle fittings. Excessive tightening torque may result into serious damage to nozzle arms and the deflector, which may affect spray pattern of the nozzle and its performance.

It is recommended that water spray system be inspected regularly by authorised technical personnel.

The nozzle must be checked for atmospheric effects, external and internal obstruction, blockage if any. The system must be operated with optimum water flow at least twice in a year or as per the provisions of NFPA /TAC or local authority having jurisdiction. The owner is solely responsible for maintaining the water spray system and the components there in so that it performs properly when required.

Model A

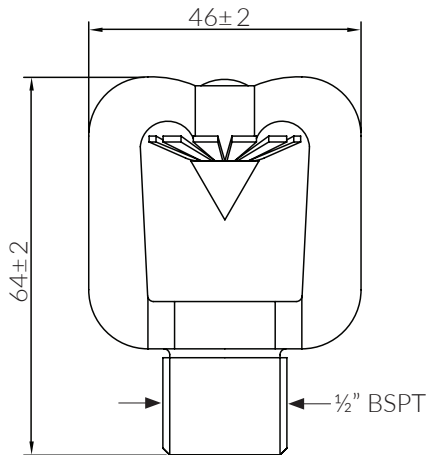

Model AS & BS

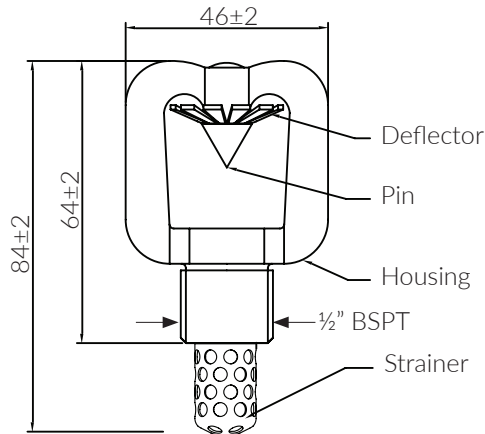

Model w/ Blow-off Plug

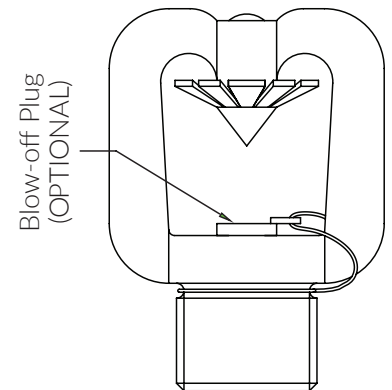

Material of Construction

Component	Model A & AS	Model BS
Housing	Brass, IS:291 GR.-1 (Equivalent To ASTM B21)	A351 - CF8M
Pin	Brass IS:291. GR. -1 (Equivalent To ASTM B21)	ASTM - A479 Gr 31803
Deflector	Brass IS:2768 (Equivalent To ASTM B36)	ASTM A240 Gr 2205
Strainer	Copper (For AS)	Stainless Steel 316 For (BS)
Blow-Off Cap	Elastomer	Elastomer

Discharge Characteristics

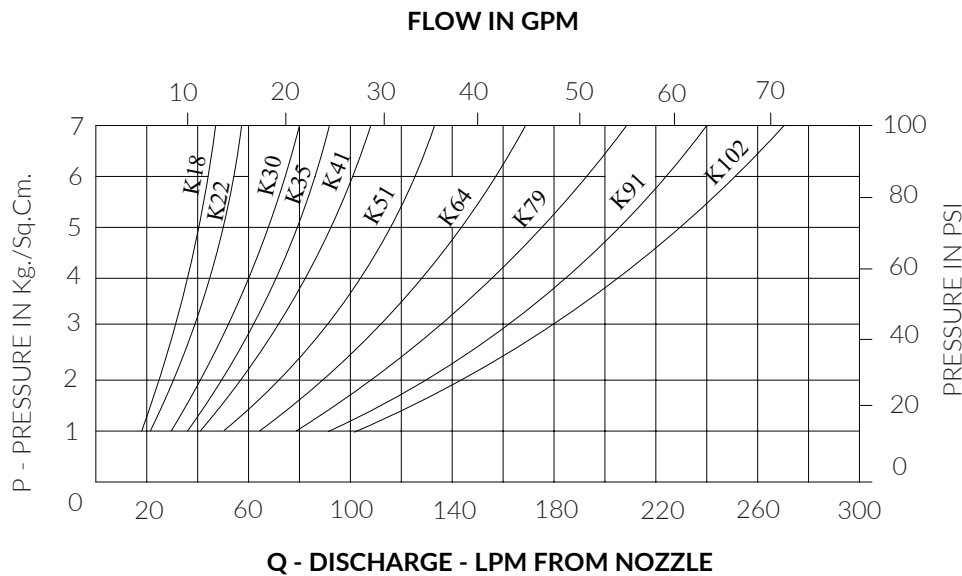

$Q = K \sqrt{P}$ where P is supply pressure in Kg/sq.cm., K= nozzle constant (K-factor) in metric
 US K factor = Metric K factor MK ÷ 14.2745

Spray Pattern

Spray Angle 65°

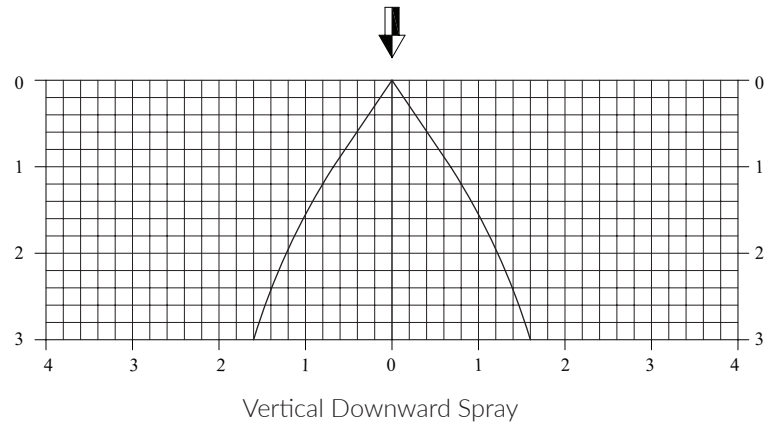
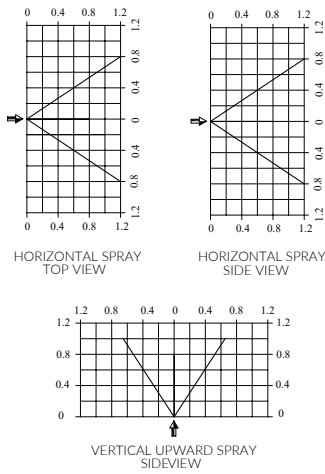

Spray Angle 80°

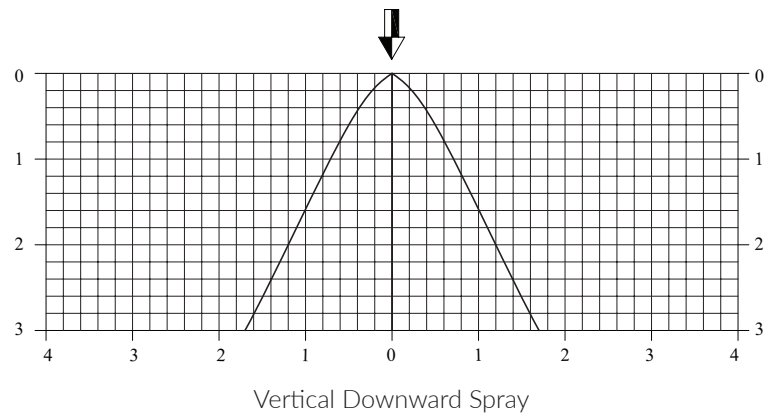
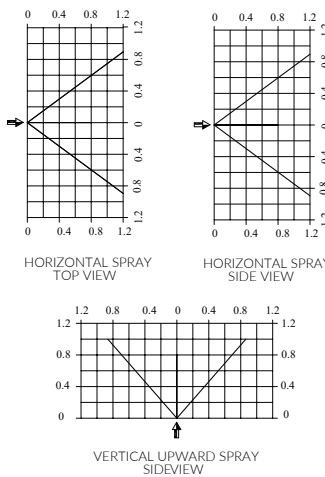

Spray Angle 90°

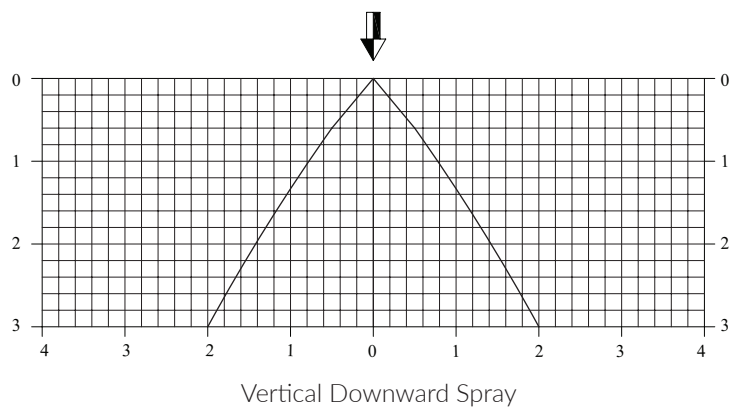
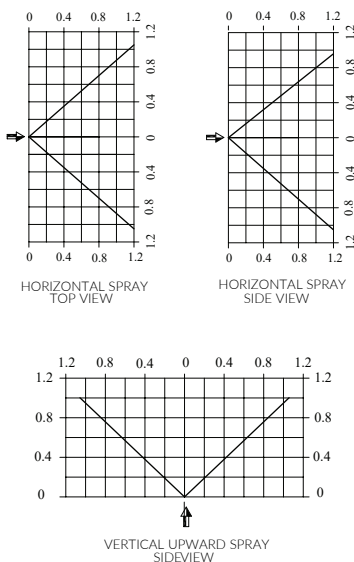

ALL DIMENSIONS ARE IN METERS

Spray Pattern

Spray Angle 100°

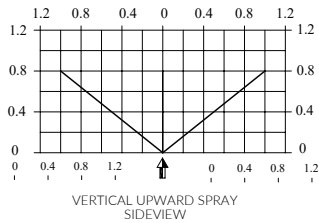
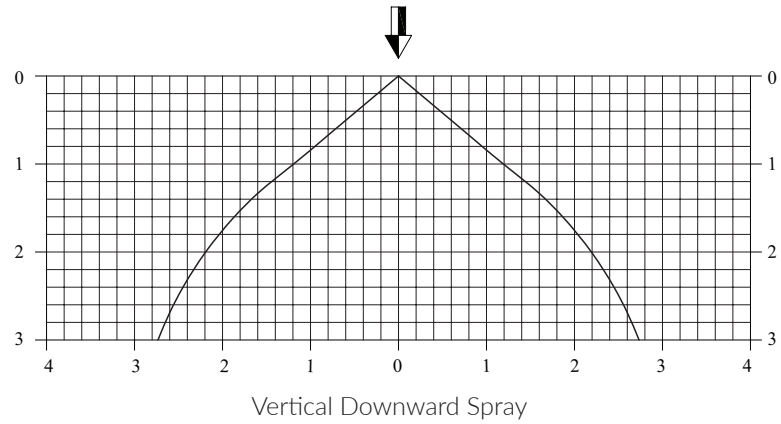
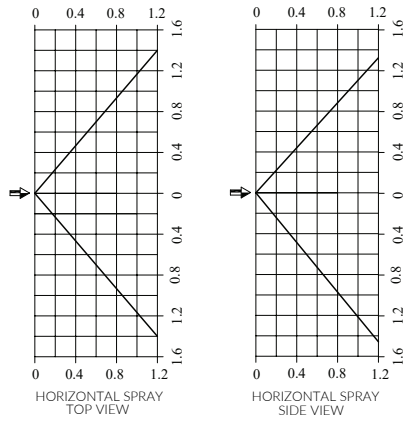

Spray Angle 110°

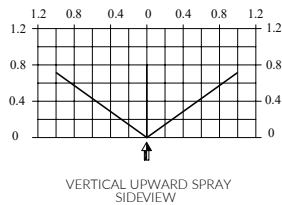
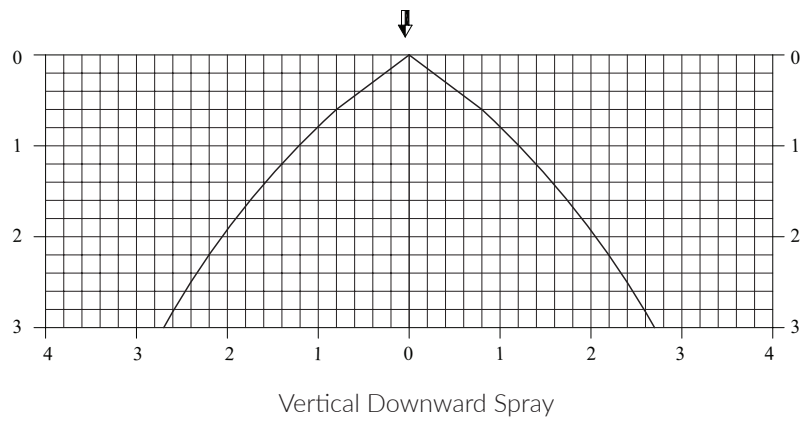
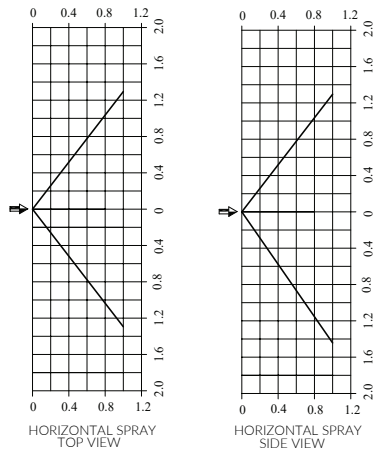

ALL DIMENSIONS ARE IN METERS

Spray Pattern

Spray Angle 120°

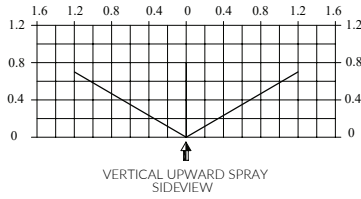
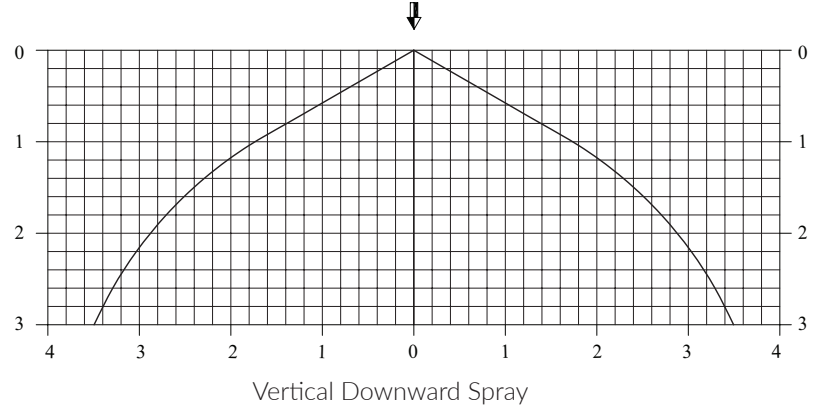
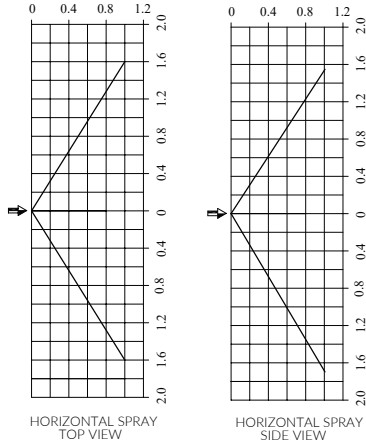

Spray Angle 140°

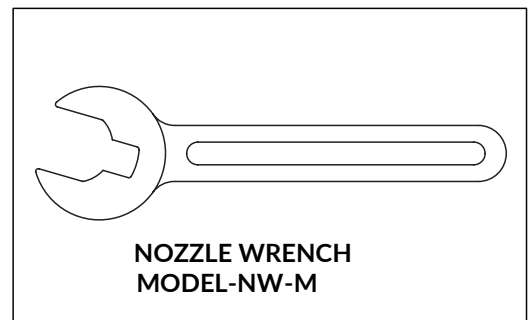
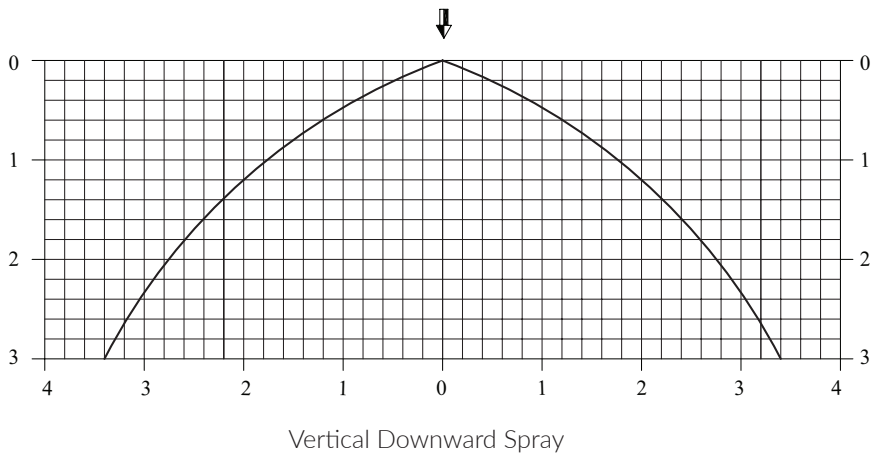
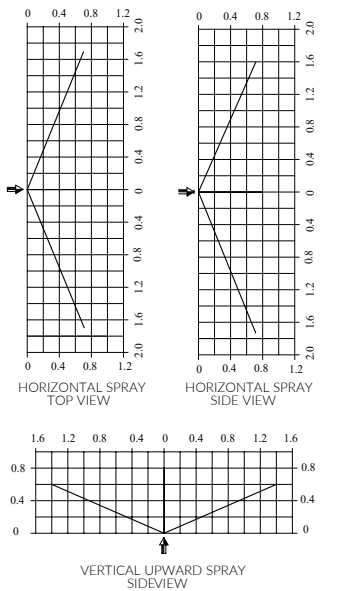

ALL DIMENSIONS ARE IN METERS